

mStrum
牙科器械



FRIOLI-VENEZIA
GIULIA

101%

ITALIAN QUALITY

意大利制造



DenTag

Maniago - Italy





DenTag® 历史

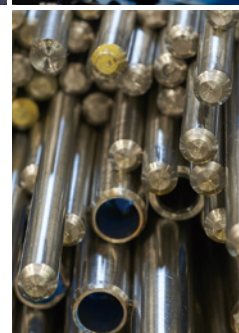
DenTag® 位于意大利东北部的马尼亚戈，一个以优质刀具闻名于世界的小镇。1950 年代初期，一群制作刀具的专家工匠成立了 DenTag，不久之后，创始人们开始专注制造高质量的外科和牙科器械。1980 年代末期，DenTag 引进了最先进的机械设备和精密的计算机技术，打造了现代化生产流程的新工厂，并精心挑选原材料 - 不锈钢，铝和钛。

DenTag® 结合几代马尼亚戈工匠的著名的回火和打磨技术，引进数控生产机械，在可以机械化处理的情况下，通过电子比较光学分析，实现生产过程完全自动化与集成化。计算机控制整个生产过程，以保证质量始终如一。某些需要精细操作的重要阶段，还是必须交由公司内部经过培训的经验熟练的工匠检查制作。这种方式成就了极佳的产品质量和富有吸引力的设计。

DenTag® 一直坚持与大学和终端用户保持沟通，便于发现最新的科学技术，根据市场的发展需求，调整产品。DenTag 如今为众多意大利和国外公司生产外科和牙科器械，品质一如既往的承袭自身的品牌。

DenTag® 的器械（两个类别 - I 类和 II 类）都完全符合当前国际标准和法令。鉴于其产品的高度专业化性质，DenTag® 收到许多新器械的需求——几乎每天都能收到类似的问询。出于这个原因，我们特别关注器械制造各个方面的创新——器械形状，材料，表面抛光。我们专注于产品的质量，辅以多功能性和不断的研究创新的生产技术。

DenTag® 一直坚持 - 101% 意大利品质。



101%
ITALIAN
QUALITY
意大利制造

INDEX

目录

1 口镜，口镜手柄，镊子，探针

诊断产品

2 刮治器，洁治器

牙周治疗

3 手术刀柄，吸唾管，过滤吸引管，骨刮匙
牙周锉，拉钩，剪刀，持针器，止血钳，骨凿
骨锉，龈切刀，骨膜剥离器，咬骨钳，拔冠钳

基础外科

4 上颌窦外提升工具，骨挤压 / 上颌窦内提升工具
骨环钻，牙龈环切刀，显微手术器械，隧道手术器械

种植器械

5 调刀，根管充填器，充填器，龈缘凿，刮匙

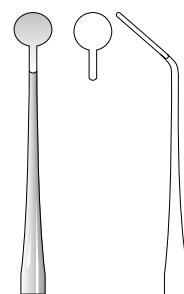
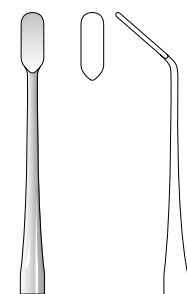
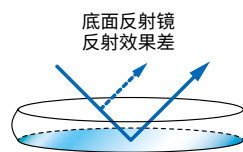
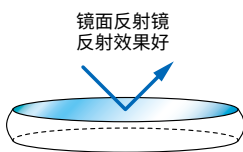
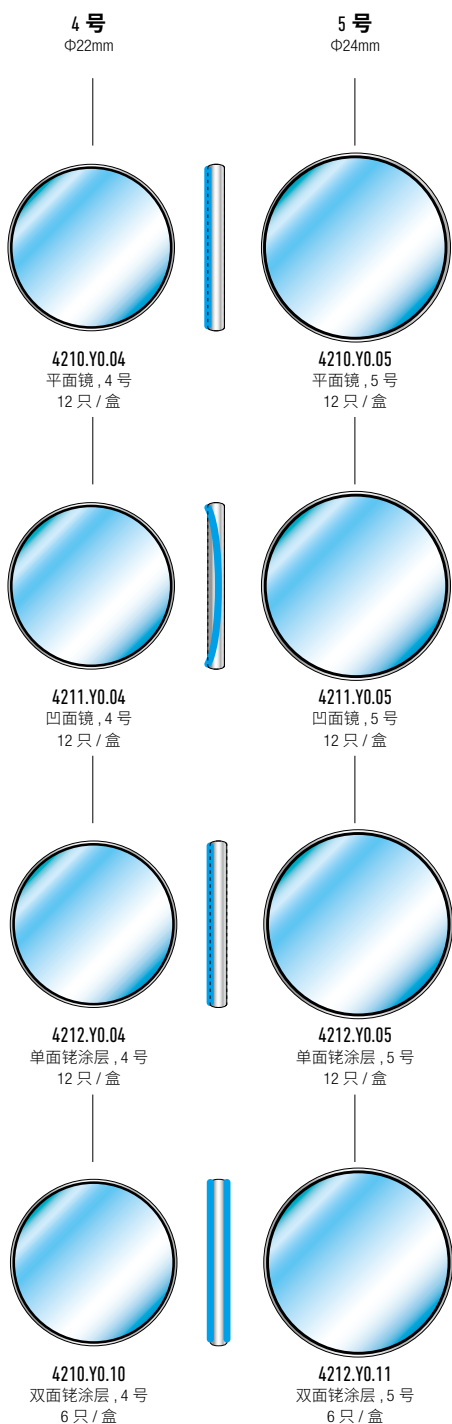
牙体牙髓

6 拔牙钳，残根钳，微创牙挺，残根挺，牙周膜分离刀

拔牙器械

7 诊断套装，刮治器套装，显微手术套装，种植套装
上颌窦外提升手术套装，上颌窦内提升手术套装

推荐套装

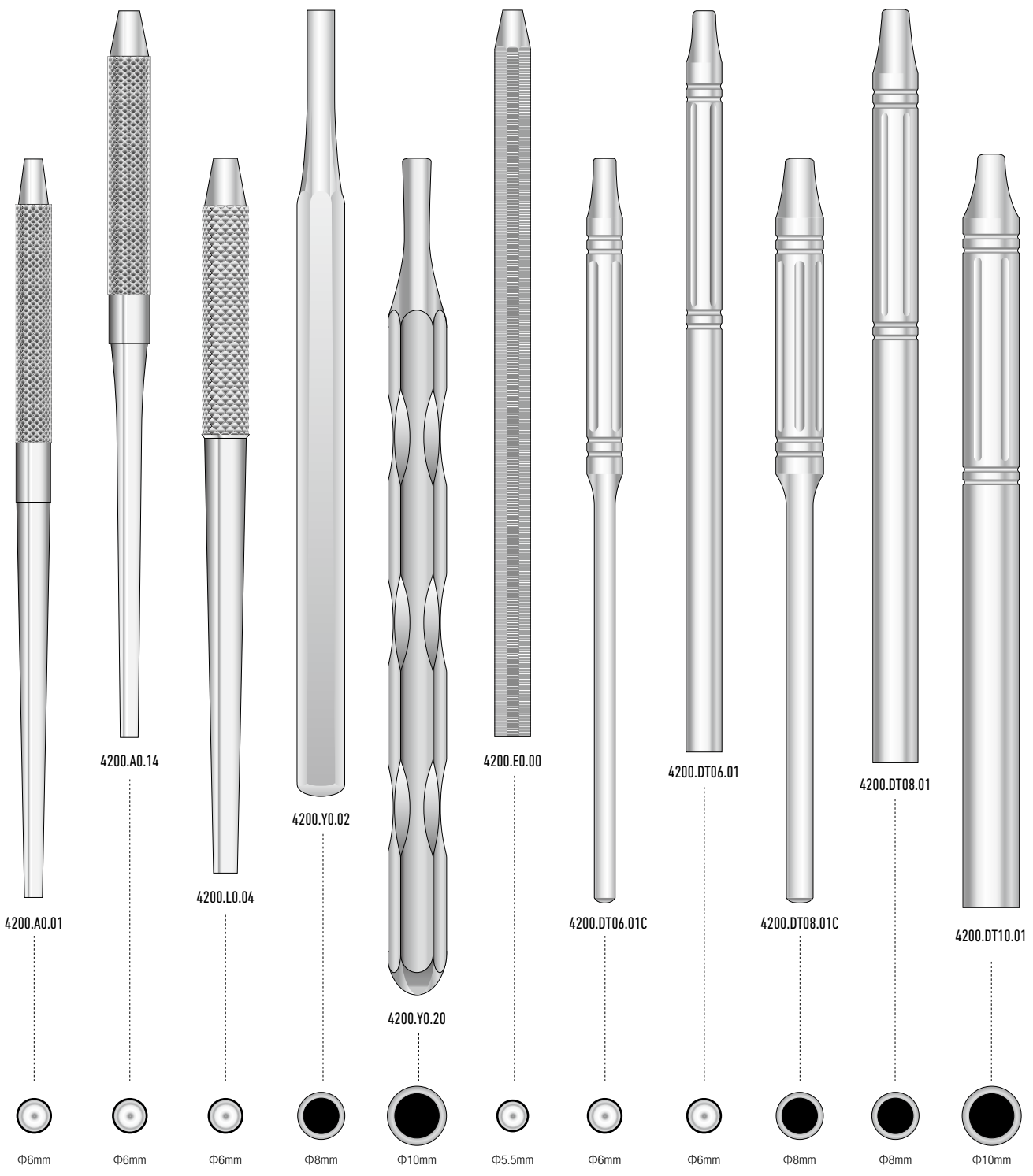


4280.DT06.01
平面显微口镜
2.5*6.0mm

4280.DT06.02
圆显微口镜
Φ5mm



1
诊断产品
口镜手柄



1 诊断产品
单工作端探针



fig. 2
0100.##.02

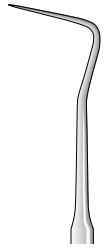


fig. 8
0100.##.08

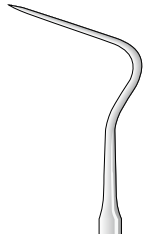


fig. 8A
0100.##.08A



fig. 9
0100.##.09



fig. 10
0100.##.10

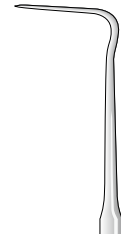


fig. 11
0100.##.11



fig. 12
0100.##.12



fig. 17
0100.##.17



fig. 17A
0100.##.17A

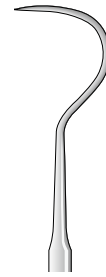


fig. 23
0100.##.23

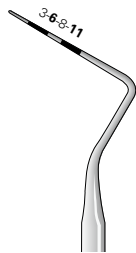


fig. CP 11
0106.##.CP11

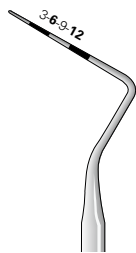


fig. CP 12
0106.##.CP12

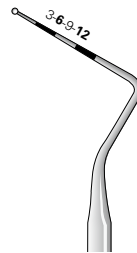


fig. CP 12S
0106.##.CP12S

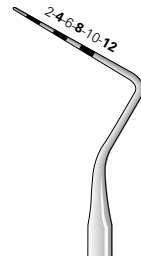


fig. CP 22
0106.##.CP22

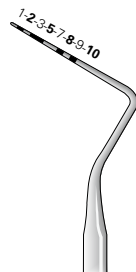


fig. CP 10
0106.##.CP10

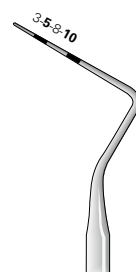


fig. CP 18
0106.##.CP18

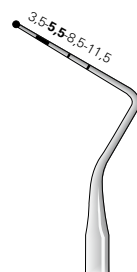


fig. WHO
0106.##.WHO

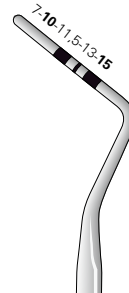


fig. BF 1
0106.##.BF 1



fig. CP 15
0106.##.CP15



1
诊断产品
双工作端探针



fig. 2
0110.##.02A

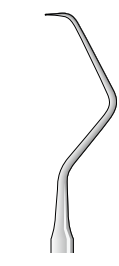


fig. 23/17A
0110.##.23/17A

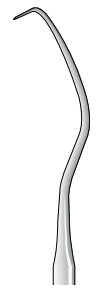
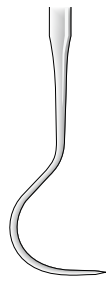


fig. UT1/2
0110.##.UT1/2



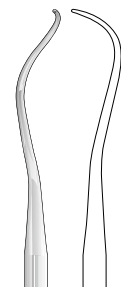
fig. 09/17
0110.##.09/17



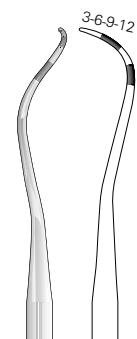
fig. 11/12
0110.##.1/12



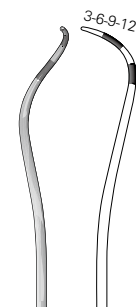
NABERS 1
0119.##.01N



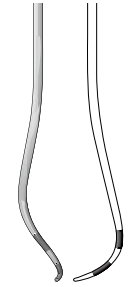
NABERS 2
0119.##.02N



NABERS 2Q
0119.##.02QN

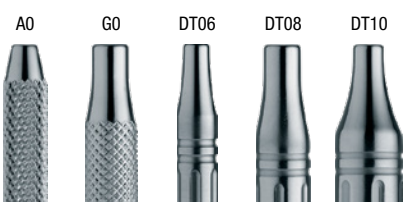


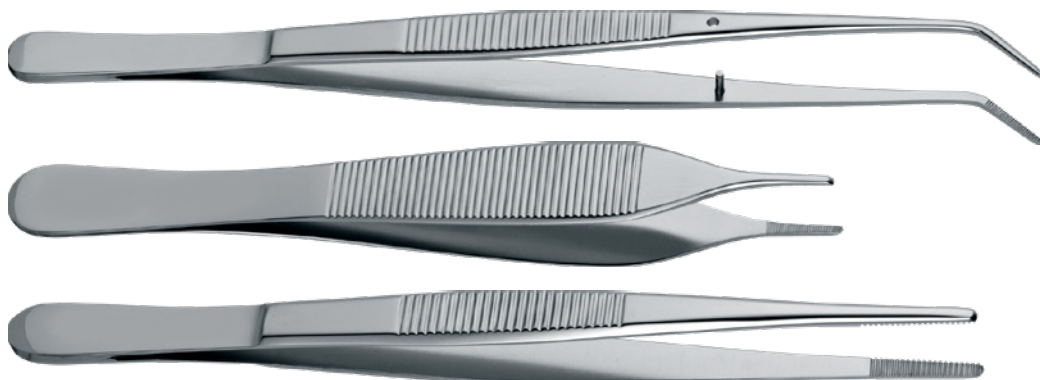
NABERS 2Q
0122.##.02N



NABERS 2Q
0119.DT08.02QN

多款手柄选择





辅料镊

LONDON - COLLEGE
6700.Y0.02
15cm, 弯

ADSON
6718.Y0.12
12cm, 直

6710.Y0.14
14cm, 直

组织镊

SEMKEN - TAYLOR
6705.Y0.51
12.5cm, 直



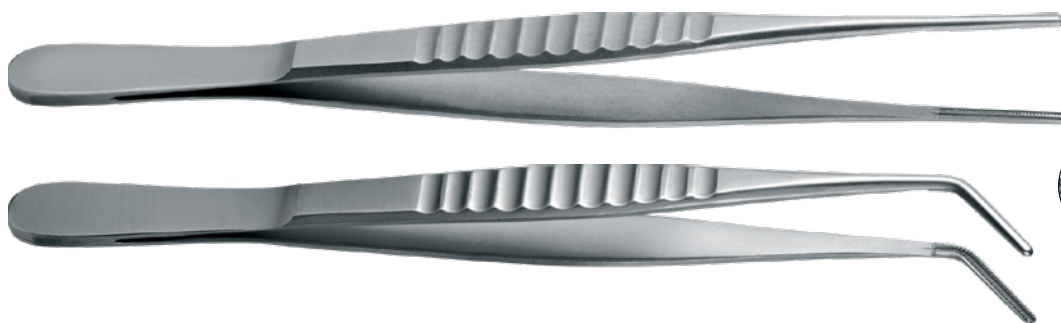
SEMKEN - TAYLOR
6705.Y0.52
12.5cm, 弯



无创伤镊

ATRAUMATIC
6715.Y0.16
15cm, 直

ATRAUMATIC
6716.Y0.16
15cm, 弯



解剖镊

ADSON
6718.Y0.12TC
12cm, 直





fig. 1/2
3/4
切牙 - 尖牙



fig. 1/2
3400.LO.01/02

fig. 3/4
切牙 - 尖牙 - 前磨牙



fig. 3/4
3400.LO.03/04

fig. 5/6
切牙 - 尖牙 - 前磨牙



fig. 5/6
3400.LO.05/06

fig. 7/8
9/10
前磨牙 - 磨牙



fig. 7/8
3400.LO.07/08



fig. 9/10
3400.LO.09/10



fig. 11/12
3400.LO.11/12

fig. 11/12
15/16
磨牙区近中区



fig. 13/14
3400.LO.13/14

fig. 13/14
17/18
磨牙区远中区



fig. 15/16
3400.LO.15/16



fig. 17/18
3400.LO.17/18

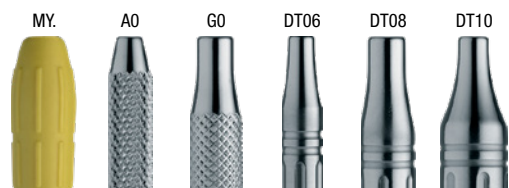
牙周治疗 刮治器

钛工作端

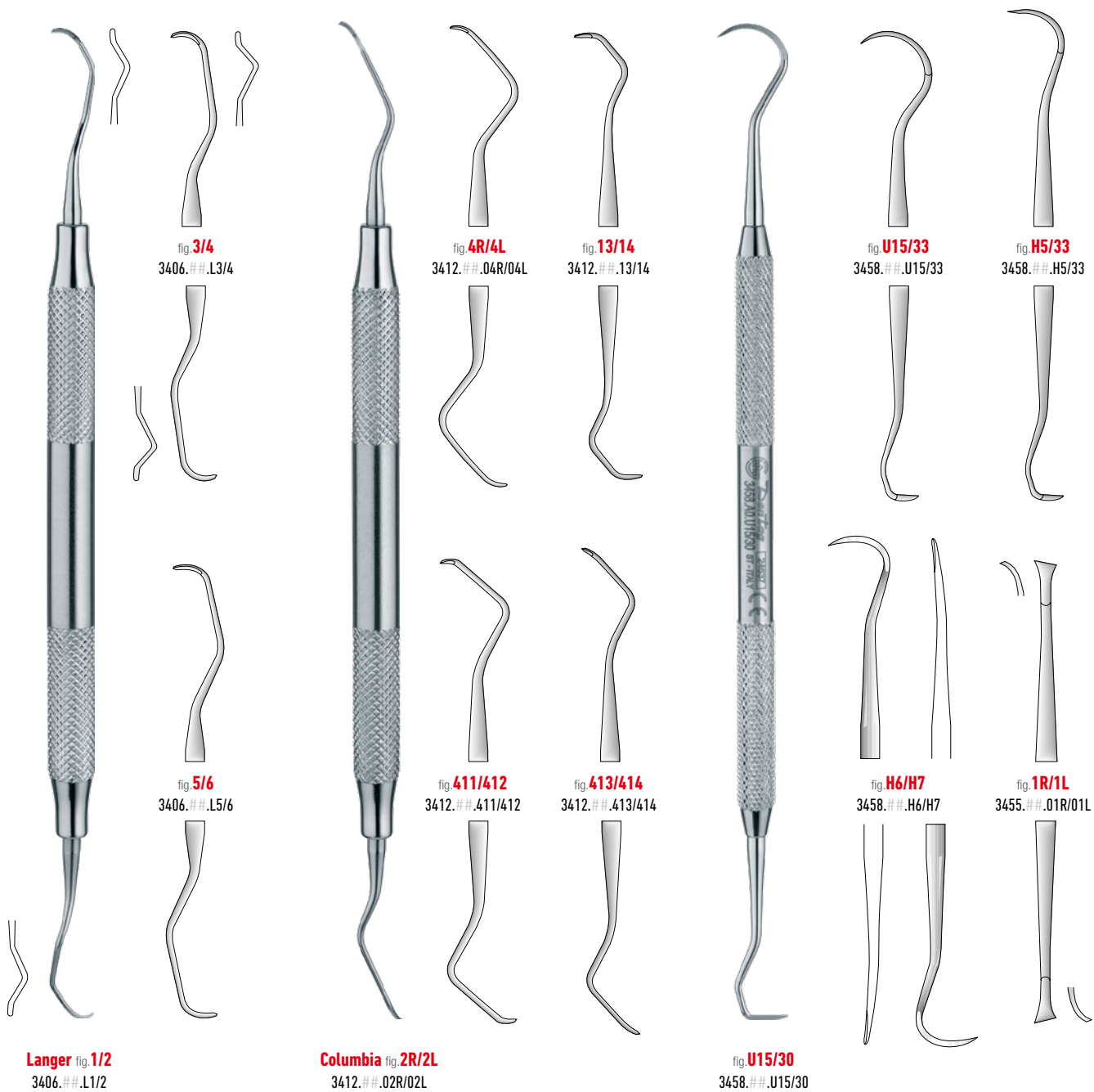
本系列产品可选钛工作端



多款手柄选择



2 牙周治疗
洁治器



钛工作端

本系列产品可选钛工作端



多款手柄选择



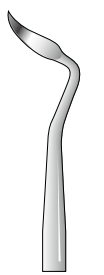


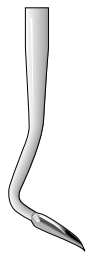
fig. **204**
3448.##.204



fig. **204S**
3448.##.204S



fig. **204SD**
3448.##.204SD



Crane-Kaplan fig. 6
3448.##.CK6

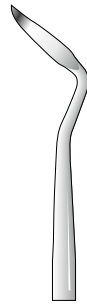


fig. **CI 2/3**
3448.##.CI2/3



Taylor fig. 2/3
3448.##.T2/3



fig. **U135**
3448.##.U135



钛工作端

本系列产品可选钛工作端



多款手柄选择

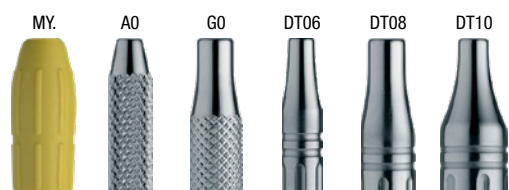




fig. 3
4600.Y0.03



fig. 5
4600.Y0.05
直



fig. 5A
4600.Y0.05A
弯

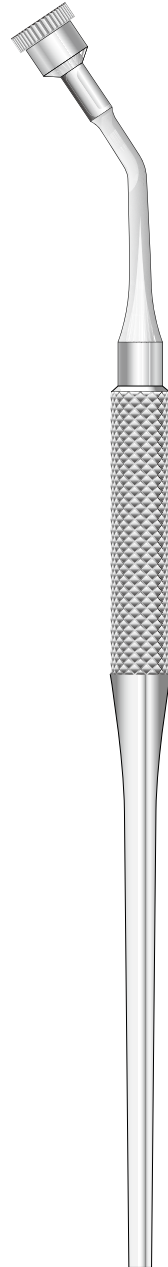


fig. 10
4600.B0.10
可定向



吸唾管

基础器械 3

过滤吸引管



2998.Y0.11 Φ 1.5 mm
2998.Y0.12 Φ 3.0 mm
2998.Y0.13 Φ 5.0 mm



2998.Y0.01



2997.Y0.01

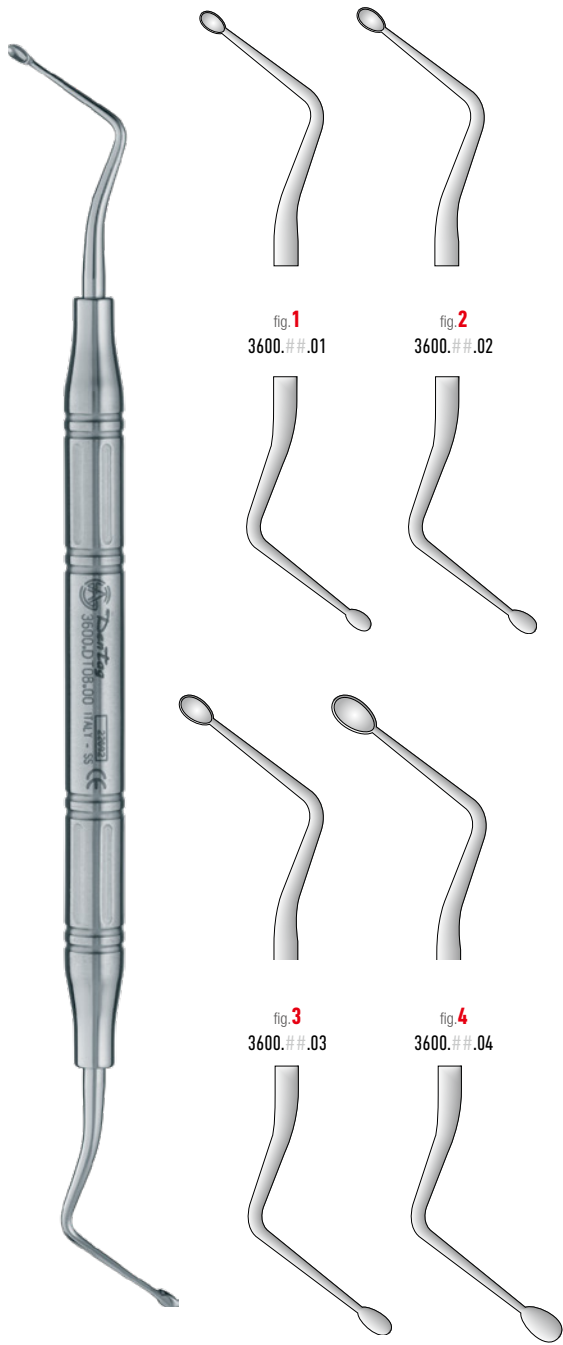


2998.Y0.F
不锈钢滤网



2997.Y0.F
特氟龙滤网

3 基础器械
骨刮匙



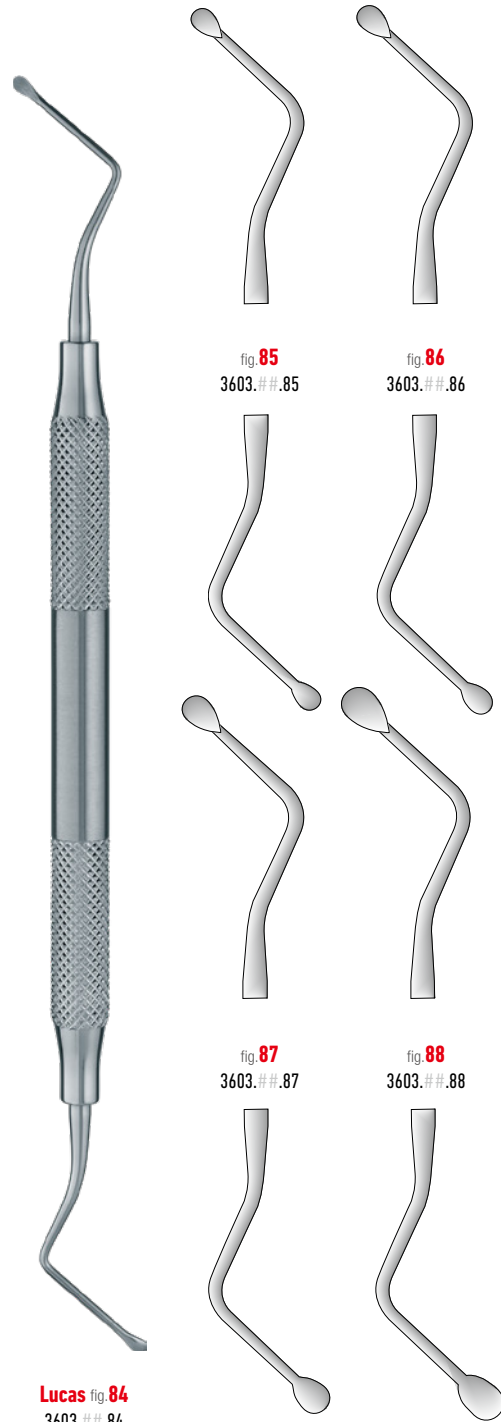
Hemingway fig. 0
3600.##.00

fig. 1
3600.##.01

fig. 2
3600.##.02

fig. 3
3600.##.03

fig. 4
3600.##.04



Lucas fig. 84
3603.##.84

fig. 85
3603.##.85

fig. 86
3603.##.86

fig. 87
3603.##.87

fig. 88
3603.##.88





基础器械
3
拉钩



Ivory 唇颊拉钩
2705.Y0.01

Caewood - Minnesota
2755.Y0.10
16 cm



半口拉钩
2706.Y0.01



颊侧拉钩
2700.Y0.01 7x25mm
2700.Y0.02 10x35mm
2700.Y0.03 10x42mm
2700.Y0.04 12x55mm
2700.Y0.05 14x70mm
2700.Y0.06 16x80mm

3 基础器械

持针器 止血钳



IRIS
11cm
6003.Y0.01 直
6003.Y0.02 弯



LA GRANGE
11.5cm
6009.Y0.01 弯, 锯齿边缘



KELLY
16cm
6012.Y0.01 直
6012.Y0.02 弯



METZENBAUM
14.5cm
6025.Y0.02




SPENCER
11cm
6021.Y0.21



 **CRILE-WOOD**
15cm
6305.Y0.15TC



 **MATHIEU**
14cm 17cm
6308.Y0.14 6308.Y0.17
6308.Y0.14TC 6308.Y0.17TC



 **MAYO-HEGAR**
16cm
6306.Y0.16TC



 **CASTROVIEJO**
18cm
6320.Y0.18TC 直
6320.Y0.18TCA 斜角
6321.Y0.18TC 弯



HALSTEAD-MOSQUITO
12cm
6355.Y0.01 直
6355.Y0.02 弯

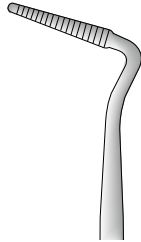




Ochsenbein
2800.A0.01 上弯
2800.A0.02 下弯



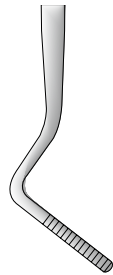
Sugarman fig. 3S/4S
3800.##.3S/4S



Schluger fig. 9/10
3800.##.9/10



Buck fig. 11/12
3800.##.11/12



Sugarman fig. 1S/2S
3800.##.1S/2S



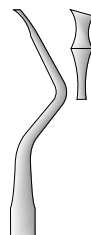
Wahl
2860.DT08.01
2860.DT08.02
2860.DT08.03



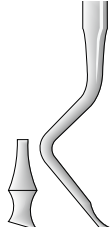
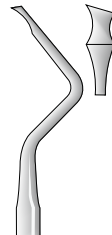
Ochsenbein
2800.##.03



Ochsenbein
2800.##.04



Rhodes 反向骨凿
2803.##.36/37



多款手柄选择

A0

G0

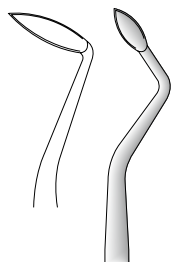
DT06

DT08

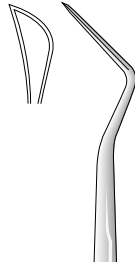
DT10



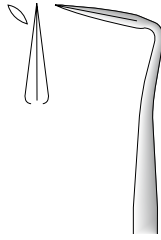
3 基础器械
龈切刀



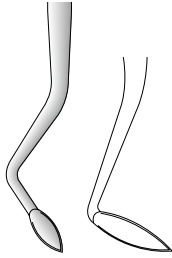
Orban fig. 1/2
3003.##.01/02



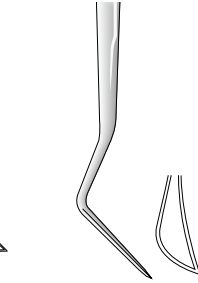
Kirkland fig. 15/16
3000.##.15/16



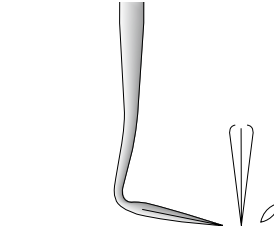
Buck fig. 5/6
3009.##.05/06



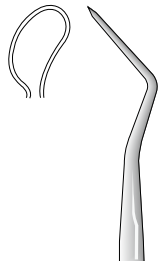
Goldman-Fox fig. 7
3006.##.07



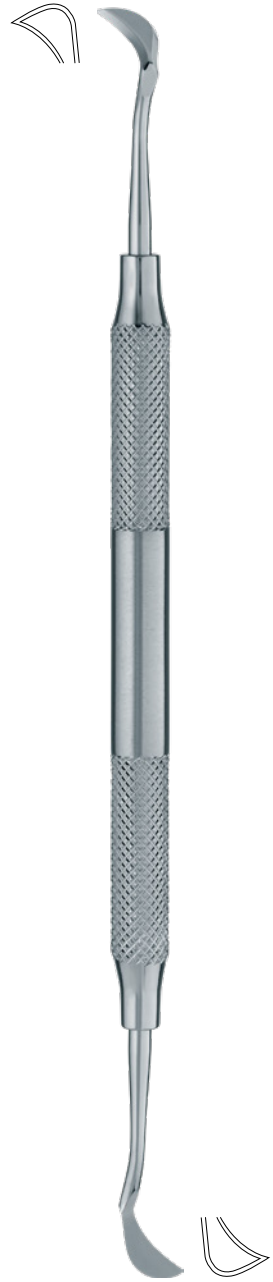
Goldman-Fox fig. 9
3006.##.09



Goldman-Fox fig. 11
3006.##.11

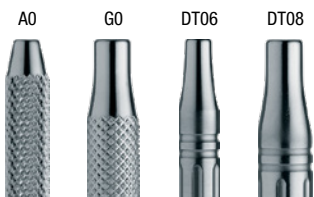


Goldman-Fox fig. 8
3006.##.08



Buck
3009.##.03/04

多款手柄选择





Hopkins fig. R2
3200.##.HR2

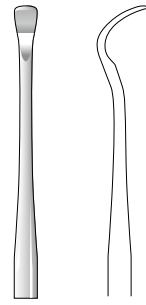


fig. 1
3210.##.01

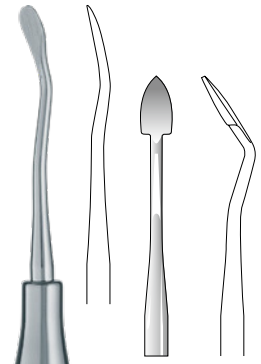
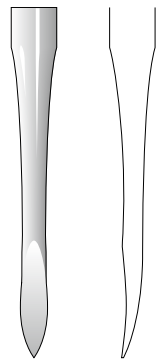


fig. B2
3250.##.B2



Prichard
3200.##.PR3



Molt fig. 9
3200.##.M9



fig. 246
3200.##.246

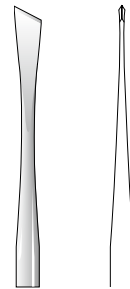


fig. 241
3204.##.241

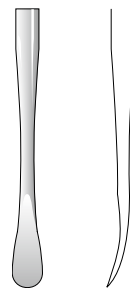
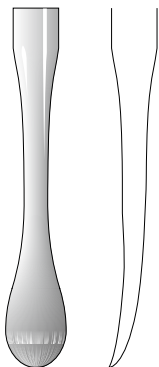


fig. B1
3250.##.B1



多款手柄选择



基础器械
3
骨膜剥离器



BLUMENTHAL
15cm / 45°
5523.Y0.15/45



BLUMENTHAL
15cm / 30°
5523.Y0.15/30



BLUMENTHAL
15cm / 90°
5523.Y0.15/90



FRIEDMAN
14cm
5520.Y0.14



fig. 1
4450.Y0.01



KLEINERT-KUTZ
16cm
5528.Y0.16



mm 6
mm 9
mm 12
mm 14
mm 17

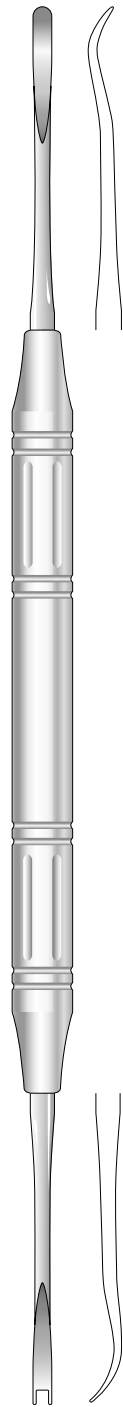
带刻度骨凿:

2900.B0.01 直, 刃宽 3.8mm
2900.B0.02 弯, 刃宽 3.8mm
2900.B0.03 直, 刃宽 7.5mm
2900.B0.04 弯, 刃宽 7.5mm

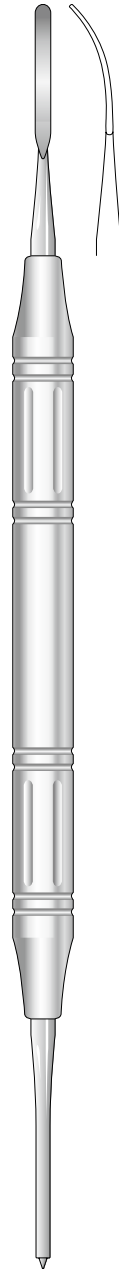


Freer 骨凿:

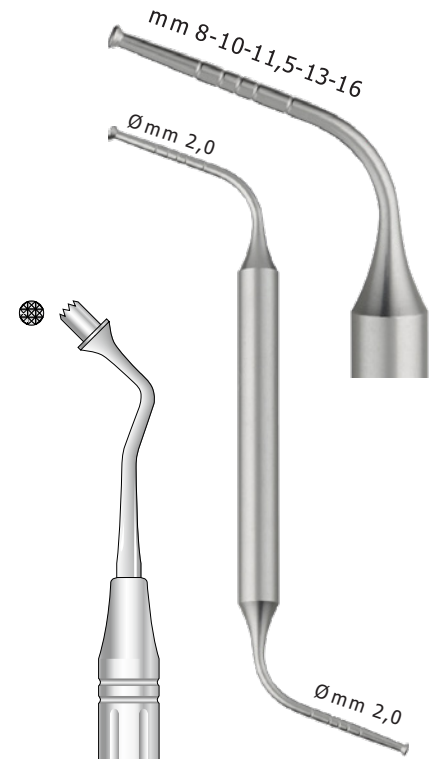
2905.B0.01 单面刃, 刃宽 2mm
2905.B0.02 单面刃, 刃宽 4mm
2905.B0.03 单面刃, 刃宽 6mm
2905.B0.11 双面刃, 刃宽 2mm
2905.B0.12 双面刃, 刃宽 4mm
2905.B0.13 双面刃, 刃宽 6mm



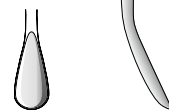
膜定位器械
2992.DT08.01



膜定位器械
2992.DT08.02



深度测量器
2951.B0.12
Φ2.0/3.0mm



骨充填器 / 窝提升器
2950.DT08.10

种植器械
4



迷你牙标卡尺
2964.Y0.01



麻醉针剂注射器
4500.Z0.02



骨碗
2960.Y0.01



骨粉碎器
2956.Z0.01





刮骨收集器
2975.Y0.02



替换刀片
2975.Y0.L

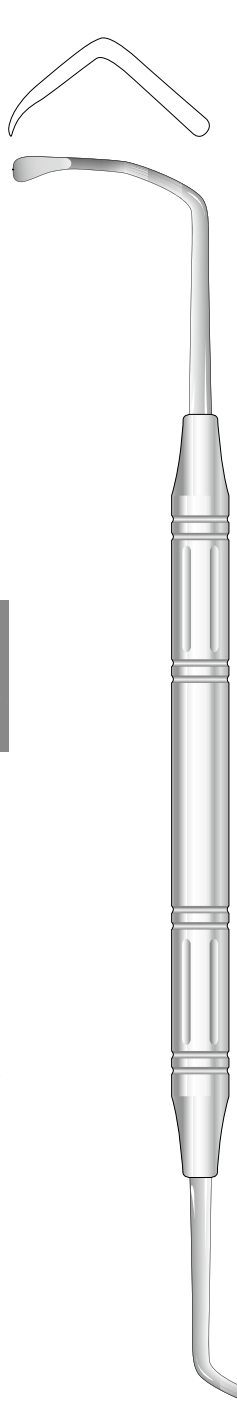


Mead 手锤
2995.Y0.01



骨厚度测量器
2967.Y0.01 直头
2967.Y0.02 弯头

4 种植器械
上颌窦提升骨膜剥离器



上颌窦提升骨膜剥离器

fig. 2
3216.##.02

fig. 3
3316.##.03

fig. 4
3216.##.04

fig. 6
3216.##.06

fig. 13
3216.##.13

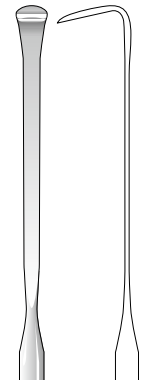


fig. 2
3295.##.02

弹性上颌窦提升骨膜剥离器

fig. 1
3295.##.01

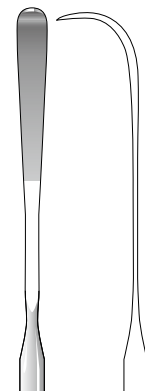


fig. 3
3295.##.03



多款手柄选择

G0

DT06

DT08





18cm
6587.Y0.18



Micro
4600.B0.50



18cm
6555.Y0.18



18cm
6505.Y0.18TC



fig. **T2**
3253.##.T2



fig. **T3**
3253.##.T3



fig. **T4**
3253.##.T4

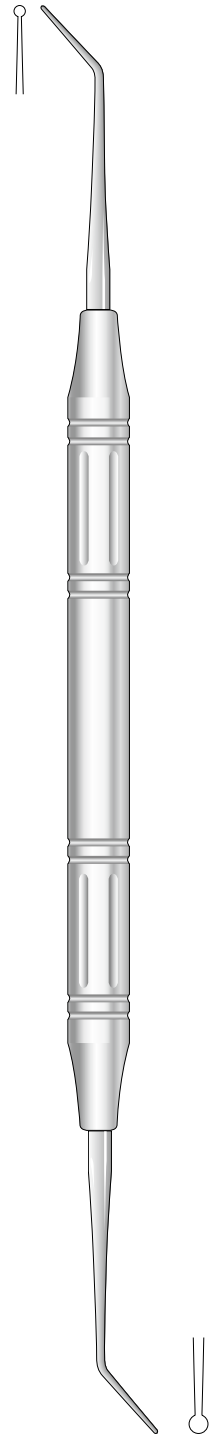
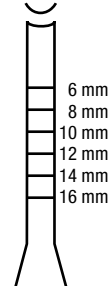
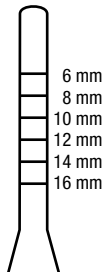


fig. **5**
3250.##.05



直头圆凸

- 2937.B0.01 $\Phi 2.2$ mm
- 2937.B0.02 $\Phi 2.5$ mm
- 2937.B0.03 $\Phi 2.8$ mm
- 2937.B0.04 $\Phi 3.1$ mm
- 2937.B0.05 $\Phi 3.5$ mm
- 2937.B0.06 $\Phi 3.8$ mm
- 2937.B0.07 $\Phi 4.1$ mm

弯头圆凸

- 2937.B0.11 $\Phi 2.2$ mm
- 2937.B0.12 $\Phi 2.5$ mm
- 2937.B0.13 $\Phi 2.8$ mm
- 2937.B0.14 $\Phi 3.1$ mm
- 2937.B0.15 $\Phi 3.5$ mm
- 2937.B0.16 $\Phi 3.8$ mm
- 2937.B0.17 $\Phi 4.1$ mm

直头圆凹

- 2937.B0.51 $\Phi 2.2$ mm
- 2937.B0.52 $\Phi 2.5$ mm
- 2937.B0.53 $\Phi 2.8$ mm
- 2937.B0.54 $\Phi 3.1$ mm
- 2937.B0.55 $\Phi 3.5$ mm
- 2937.B0.56 $\Phi 3.8$ mm
- 2937.B0.57 $\Phi 4.1$ mm

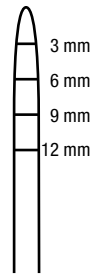
弯头圆凹

- 2937.B0.61 $\Phi 2.2$ mm
- 2937.B0.62 $\Phi 2.5$ mm
- 2937.B0.63 $\Phi 2.8$ mm
- 2937.B0.64 $\Phi 3.1$ mm
- 2937.B0.65 $\Phi 3.5$ mm
- 2937.B0.66 $\Phi 3.8$ mm
- 2937.B0.67 $\Phi 4.1$ mm



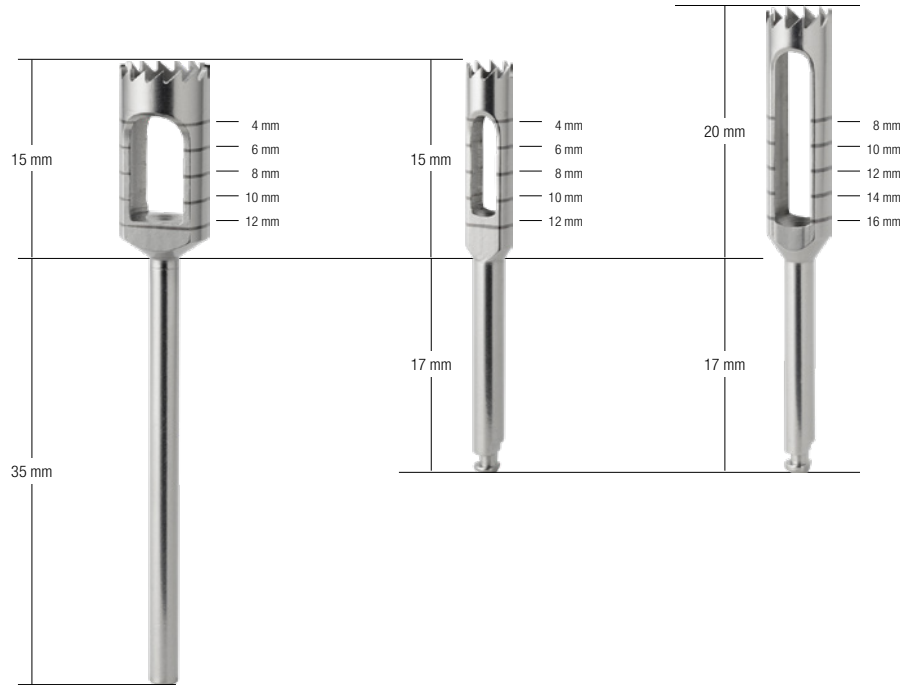
直柄骨扩张器

- 2940.B0.01 刃宽 2.2 mm
- 2940.B0.02 刃宽 2.8 mm
- 2940.B0.03 刃宽 3.4 mm
- 2940.B0.04 刃宽 4.0 mm





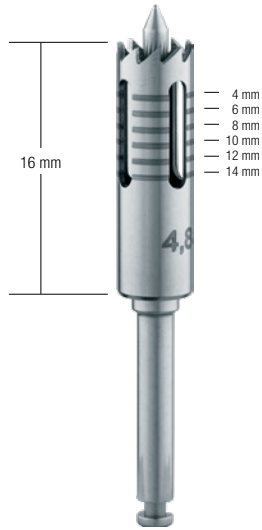
角度手柄骨扩张器

- 2940.B0.11 刃宽 2.2 mm
- 2940.B0.12 刃宽 2.8 mm
- 2940.B0.13 刃宽 3.4 mm
- 2940.B0.14 刃宽 4.0 mm



4 种植器械
骨环钻

内/外径 (mm)	钻长/柄长 (mm)		
	15/35	15/17	20/17
内  外 	钻身刻度: 4/6/8/10/12 (mm)		钻身刻度: 8/10/12/14/16 (mm)
2.5/3		2982.Y0.25	
3/3.5		2982.Y0.30	
3.5/4		2982.Y0.35	2983.Y0.35
4/4.5		2982.Y0.40	2983.Y0.40
4/5	2985.Y0.40		
4.5/5		2982.Y0.45	2983.Y0.45
5/6		2982.Y0.50	2983.Y0.50
5.5/6.5		2982.Y0.55	
6/7	2985.Y0.60	2982.Y0.60	2983.Y0.60
6.5/7.5		2982.Y0.65	
7/8		2982.Y0.70	2983.Y0.70
7.5/8.5		2982.Y0.75	
8/9		2982.Y0.80	
8.5/9.5		2982.Y0.85	
9/10		2982.Y0.90	
9.2/10			2983.Y0.92
9.5/10.5		2982.Y0.95	
10/11	2985.Y0.100	2982.Y0.100	
14/16			2983.Y0.140



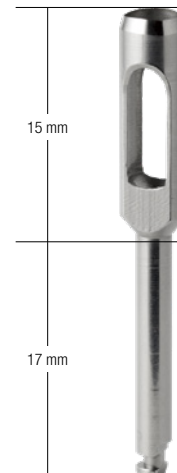
外径 (mm)	钻长 16 (mm)
钻身刻度: 4/6/8/10/12/14 (mm)	
3.3	2986.Y0.33
3.8	2986.Y0.38
4.3	2986.Y0.43
4.8	2986.Y0.48

骨环钻

种植器械 4

牙龈环切刀

内/外径 (mm)	钻长/柄长 = 15/17 (mm)
3/3.5	2984.Y0.30
3.5/4	2984.Y0.35
4/4.5	2984.Y0.40
4.5/5	2984.Y0.45
5/6	2984.Y0.50
5.5/6.5	2984.Y0.55
6/7	2984.Y0.60



5 调刀 牙体牙髓 根管填充器



0301.DT08.01

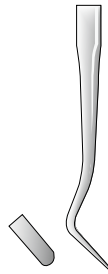
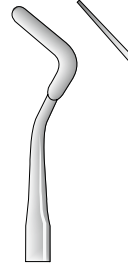
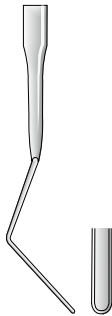
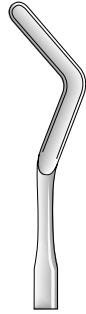


0303.DT08.A1 5.0mm
0303.DT08.A2 6.5mm
0303.DT08.A3 8.0mm



Heidemann

- 0500.##.01 2.0mm
- 0500.##.02 2.5mm
- 0500.##.03 3.0mm
- 0500.##.11 2.0mm 锋利
- 0500.##.12 2.5mm 锋利
- 0500.##.13 3.0mm 锋利



- 1112.##.00 1.5mm
- 1112.##.01 2.0mm
- 1112.##.02 2.5mm
- 1112.##.03 3.0mm



0807.##.11



0807.##.12

调刀

根管填充器

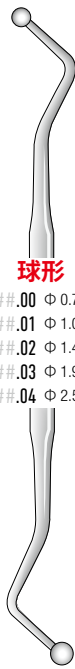
多款手柄选择





球形

- 0800.##.00 Φ 0.7/0.9mm
- 0800.##.01 Φ 1.0/1.2mm
- 0800.##.02 Φ 1.4/1.7mm
- 0800.##.03 Φ 1.9/2.2mm
- 0800.##.04 Φ 2.5/3.0mm



水滴形

- 0803.##.01
- 0803.##.02
- 0803.##.03



平面

- 0806.##.01L Φ 1.1/1.4mm
- 0806.##.02L Φ 1.7/2.0mm
- 0806.##.03L Φ 2.2/2.5mm



圆柱形

- 0809.##.01 Φ 1.1/1.4mm
- 0809.##.02 Φ 1.7/2.0mm
- 0809.##.03 Φ 2.2/2.5mm



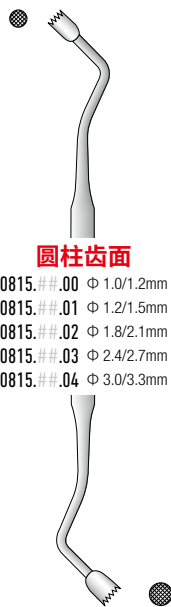
齿面

- 0812.##.01L Φ 1.2/1.5mm
- 0812.##.02L Φ 1.8/2.1mm
- 0812.##.03L Φ 2.4/2.7mm
- 0812.##.04L Φ 3.0/3.3mm



圆柱齿面

- 0815.##.00 Φ 1.0/1.2mm
- 0815.##.01 Φ 1.2/1.5mm
- 0815.##.02 Φ 1.8/2.1mm
- 0815.##.03 Φ 2.4/2.7mm
- 0815.##.04 Φ 3.0/3.3mm



锥形

- 0833.##.01
- 0833.##.02
- 0833.##.30



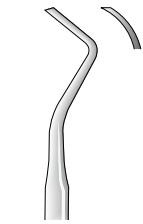
充填器

5
牙体牙髓
充填器



多款手柄选择

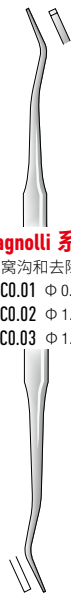




Black 系列
用以窝洞预备过程中修整牙龈边缘
1700.##.28 适用远中面
1700.##.29 适用近中面



Bertagnolli 系列
用以修整窝沟和去除残留物
1707.CO.01 Φ 0.5mm
1707.CO.02 Φ 1.0mm
1707.CO.03 Φ 1.5mm



龈缘凿



圆形
2600.##.01
2600.##.03
2600.##.04



椭圆形
2606.##.17W
2606.##.18W
2606.##.19W



fig. **210/211**
2615.##.210/1



fig. **212/213**
2615.##.212/3



fig. **216/217**
2615.##.216/7



fig. **220/221**
2615.##.220/1



刮匙

多款手柄选择

A0

GO

DT06

DT08

DT10





拔牙钳



fig. 01
5310.Y0.01



fig. 13
5310.Y0.13



fig. 17
5310.Y0.17



fig. 18
5310.Y0.18



fig. 22
5310.Y0.22



fig. 67A
5310.Y0.67A



fig. 79
5310.Y0.79

残根钳



fig. 333S
5310.Y0.333S



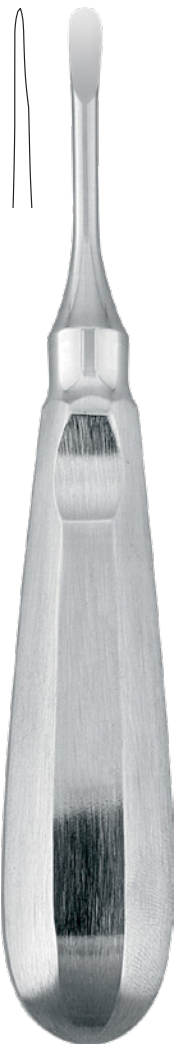
fig. 46L
5310.Y0.46L



fig. 49
5310.Y0.49

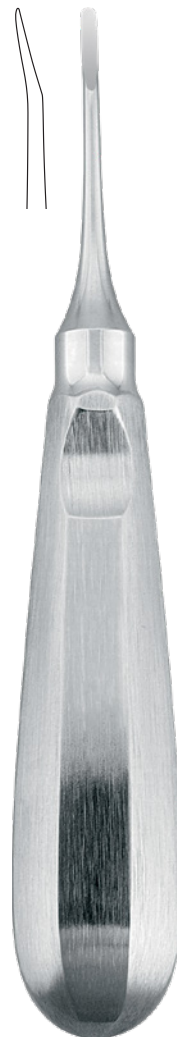


fig. 97
5310.Y0.97



直头

- 4795.00.02S 宽 2mm
- 4795.00.03S 宽 3mm
- 4795.00.04S 宽 4mm
- 4795.00.05S 宽 5mm



弯头

- 4795.00.02C 宽 2mm
- 4795.00.03C 宽 3mm
- 4795.00.04C 宽 4mm
- 4795.00.05C 宽 5mm



Periotome
牙周膜分离刀
4790.B0.49



fig. 1
4790.Z0.01



fig. 11
4790.Z0.11

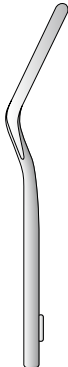


fig. 2
4790.Z0.02

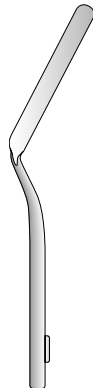


fig. 12
4790.Z0.12

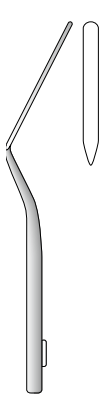


fig. 3
4790.Z0.03

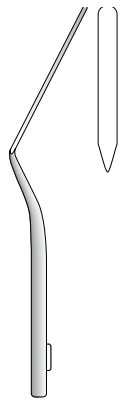


fig. 13
4790.Z0.13

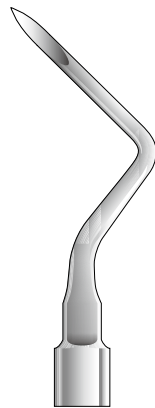


fig. 3/4
4760.##.03/04

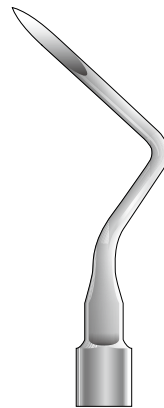
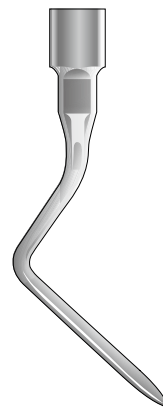


fig. 5/6
4760.##.05/06



Heidbrinck fig. 1/2
4760.G0.01/02



fig. 02 - STIEGLITZ
5350.Y0.02



残根挺



8110.Y0.05
180 x 85 x 20h (mm)



8111.Y0.15
185 x 140 x 20h (mm)



8115.Y0.10
205 x 143 x 34h (mm)



8115.Y0.20
280 x 205 x 32h (mm)

诊断套装

0110.DT08.23/17A	双向探针	直径 8MM 不锈钢手柄	1
4210.Y0.05	口镜	圆形直径 24MM	1
4200.Y0.02	口镜手柄	六角形中空手柄	1
6700.Y0.02	镊子	弯头 15CM 长	1

刮治器套装

3400.L0.01/02	刮治器	黄色直径 8MM 铝制手柄	1
3400.L0.03/04	刮治器	红色直径 8MM 铝制手柄	1
3400.L0.05/06	刮治器	蓝色直径 8MM 铝制手柄	1
3400.L0.07/08	刮治器	绿色直径 8MM 铝制手柄	1
3400.L0.09/10	刮治器	银色直径 8MM 铝制手柄	1
3400.L0.11/12	刮治器	黑色直径 8MM 铝制手柄	1
3400.L0.13/14	刮治器	褐色直径 8MM 铝制手柄	1
8115.Y0.10	可消毒器械盒	205*143*34MM 可放 10 件	1

牙周手术套装

0110.DT08.23/17A	双向探针	直径 8MM 不锈钢手柄	1
2804.G0.01	骨凿	直径 8MM 不锈钢手柄	1
2998.Y0.11	吸唾管	1.5MM 口径	1
3200.DT08.PR3	骨膜剥离器	直径 8MM 不锈钢手柄	1
3250.G0.B1	骨膜剥离器	直径 8MM 不锈钢手柄	1
3412.DT08.13/14	刮治器	直径 8MM 不锈钢手柄	1
3603.DT08.86	骨刮匙	直径 8MM 不锈钢手柄	1
4200.Y0.02	口镜手柄	六角形中空手柄	1
4212.Y0.04	口镜	单面镀铍圆形直径 22MM	1
4600.Y0.03	解剖刀手柄	用以夹持刀片	1
6012.Y0.02	手术剪	弯头, 长 16CM	1
6306.Y0.16TC	持针器	长 16CM, 钨碳合金	1
6705.Y0.52	组织镊	弯头, 长 12.5CM	1

上颌窦内提升手术套装

2937.B0.61	上颌窦内提升器	弯头圆凹, 直径 2.2MM	1
2937.B0.62	上颌窦内提升器	弯头圆凹, 直径 2.5MM	1
2937.B0.63	上颌窦内提升器	弯头圆凹, 直径 2.8MM	1
2937.B0.64	上颌窦内提升器	弯头圆凹, 直径 3.1MM	1
2937.B0.65	上颌窦内提升器	弯头圆凹, 直径 3.5MM	1
2937.B0.66	上颌窦内提升器	弯头圆凹, 直径 3.8MM	1
2937.B0.67	上颌窦内提升器	弯头圆凹, 直径 4.1MM	1
8115.Y0.10	可消毒器械盒	205*143*34MM 可放 10 件	1



种植专家套装

0106.DT06.CP12S	色标牙周探针	刻度为 3-6-9-12MM	1
0110.DT08.02A	双向探针	直径 8MM 不锈钢手柄	1
2600.DT08.04	挖凿器	直径 8MM 不锈钢手柄	1
2860.DT08.02	骨锉	直径 8MM 不锈钢手柄	1
2900.B0.02	解剖弯凿刀	刃宽 3.8MM	1
2900.B0.04	解剖弯凿刀	刃宽 7.5MM	1
2951.B0.12	骨深度测量仪	刻度为 8-10-11.5-13-16MM	1
2956.Z0.01	骨粉碎器	用以自体骨碾压粉碎	1
2960.Y0.01	骨收集器	用以收集碎骨	1
2964.Y0.01	迷你牙标卡尺	测量牙齿和植入物的距离	1
2967.Y0.02	骨厚度测量器	刻度范围 0-40MM	1
2975.Y0.02	弯头刮骨收集器	用以自体骨收集	1
2995.Y0.01	手锤	特氟龙锤头	1
2998.Y0.11	吸唾管	1.5MM 口径	1
3200.DT08.M9	骨膜剥离器	直径 8MM 不锈钢手柄	1
3200.DT08.PR3	骨膜剥离器	直径 8MM 不锈钢手柄	1
3210.DT08.01	骨膜剥离器	直径 8MM 不锈钢手柄	1
3603.A0.88	骨刮匙器	直径 6MM 不锈钢手柄	1
4200.Y0.02	空心手柄	六角形中空手柄	1
4211.Y0.05	口镜	圆形直径 24MM	1
4600.Y0.03	解剖刀手柄	用以夹持刀片	1
6009.Y0.01	手术剪	弯头, 长 11.5CM	1
6021.Y0.21	手术剪	长 11CM	1
6025.Y0.02	手术剪	弯圆头, 长 14.5CM	1
6306.Y0.16TC	持针器	长 16CM, 钨碳合金	1
6355.Y0.02	止血钳	弯头	1
6700.Y0.02	辅料镊	弯头 15CM 长	1
6718.Y0.12	组织镊	长 12CM	1
8115.Y0.20	可消毒工具箱	280*205*32MM 可放 20 件	1

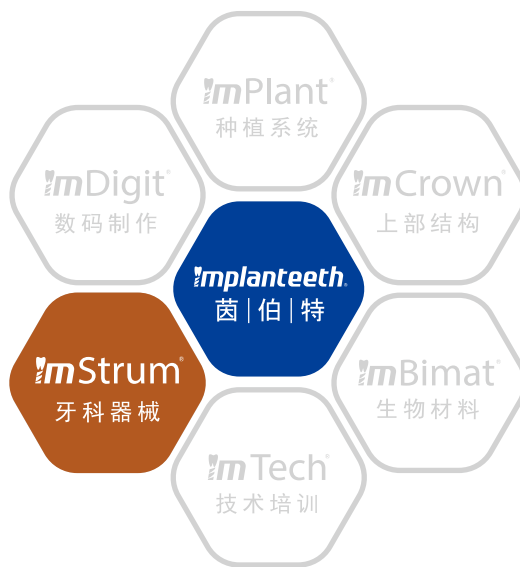
上颌窦外提升手术套装

2951.B0.12	深度测量器	刻度为 8-10-11.5-13-16MM	1
3200.DT08.PR3	骨膜剥离器	直径 8MM 不锈钢手柄	1
3216.DT08.02	上颌窦提升骨膜剥离器	直径 8MM 不锈钢手柄	1
3216.DT08.03	上颌窦提升骨膜剥离器	直径 8MM 不锈钢手柄	1
3216.DT08.04	上颌窦提升骨膜剥离器	直径 8MM 不锈钢手柄	1
3216.DT08.06	上颌窦提升骨膜剥离器	直径 8MM 不锈钢手柄	1
3295.DT08.01	弹性上颌窦提升器	直径 8MM 不锈钢手柄	1
3295.DT08.02	弹性上颌窦提升器	直径 8MM 不锈钢手柄	1
3295.DT08.03	弹性上颌窦提升器	直径 8MM 不锈钢手柄	1
8115.Y0.10	可消毒器械盒	205*143*34MM 可放 10 件	1

推荐
8
套装

ImStrum®

牙科器械



种植牙全方位解决方案

COMPREHENSIVE SOLUTIONS FOR IMPLANTEETH



Implanteeth®
茵伯特（上海）医疗技术有限公司

地址：上海市松江区民益路201号6号楼403室
Room 403, Building 6, NO.201, Minyi Road,
Songjiang District, Shanghai, 201612, PRC

Tel : 86-21-37011189
86-21-37011181 (订货咨询 Order Consultation)
Fax : 86-21-37011182 37011183

省级经销商联系方式粘贴处